





Section A = 5000 m  
SA-km1-CTF1-km2-CTF2-km3-km4-CTF3-km5-FA  
Section T = 800 m  
ST - CTF 1 - FT

SA

CTF 2  
Km 3

FB

rest area

SB

CTF 1

TRANSFER

Km 1-2-4-5  
FA/ST

CTF 1-3



riding

Google



# Section B = 6770 m

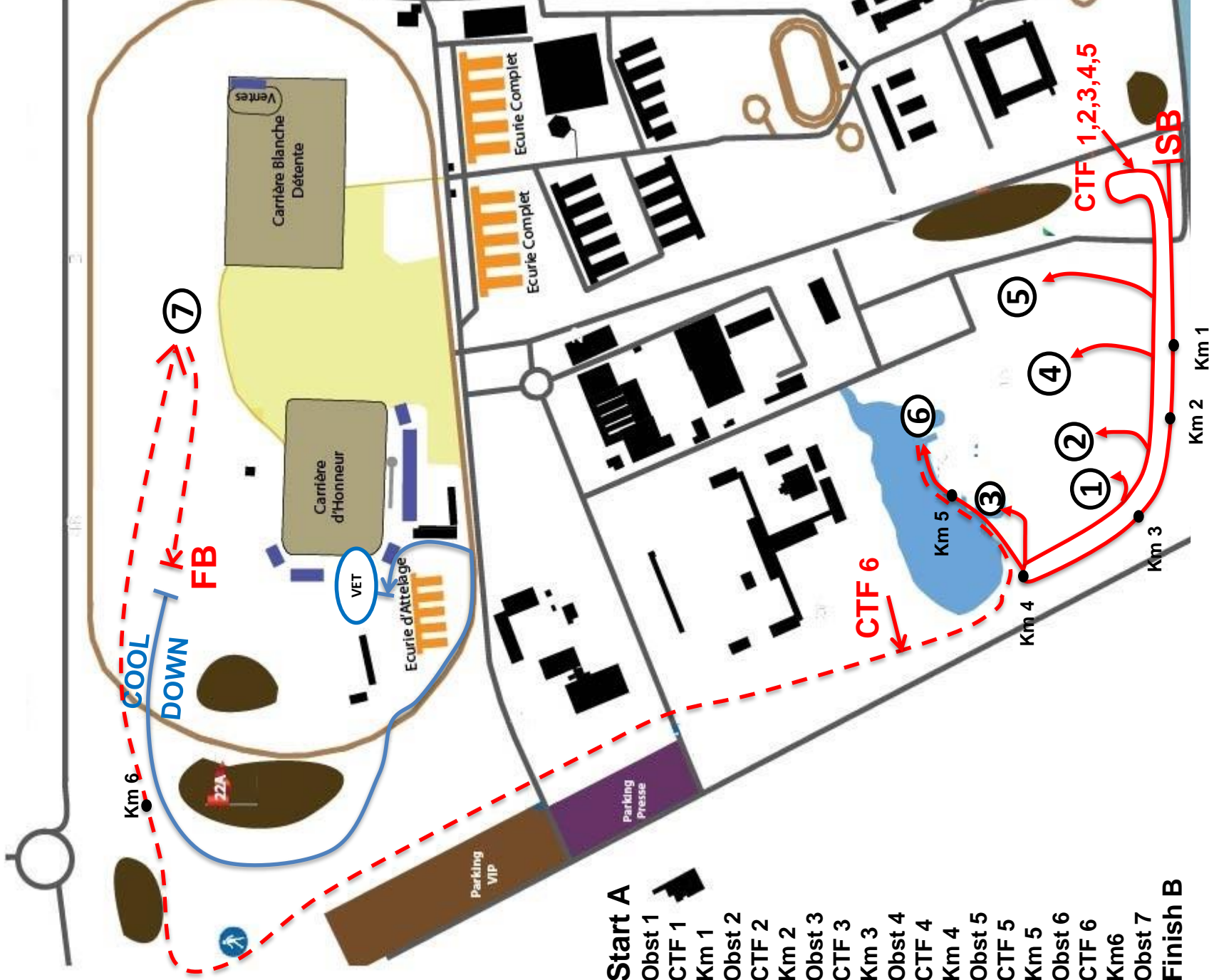

- Start A
- Obst 1
- CTF 1
- Km 1
- Obst 2
- CTF 2
- Km 2
- Obst 3
- CTF 3
- Km 3
- Obst 4
- CTF 4
- Km 4
- Obst 5
- CTF 5
- Km 5
- Obst 6
- CTF 6
- Km 6
- Obst 7
- Finish B

# Obstacle n°1

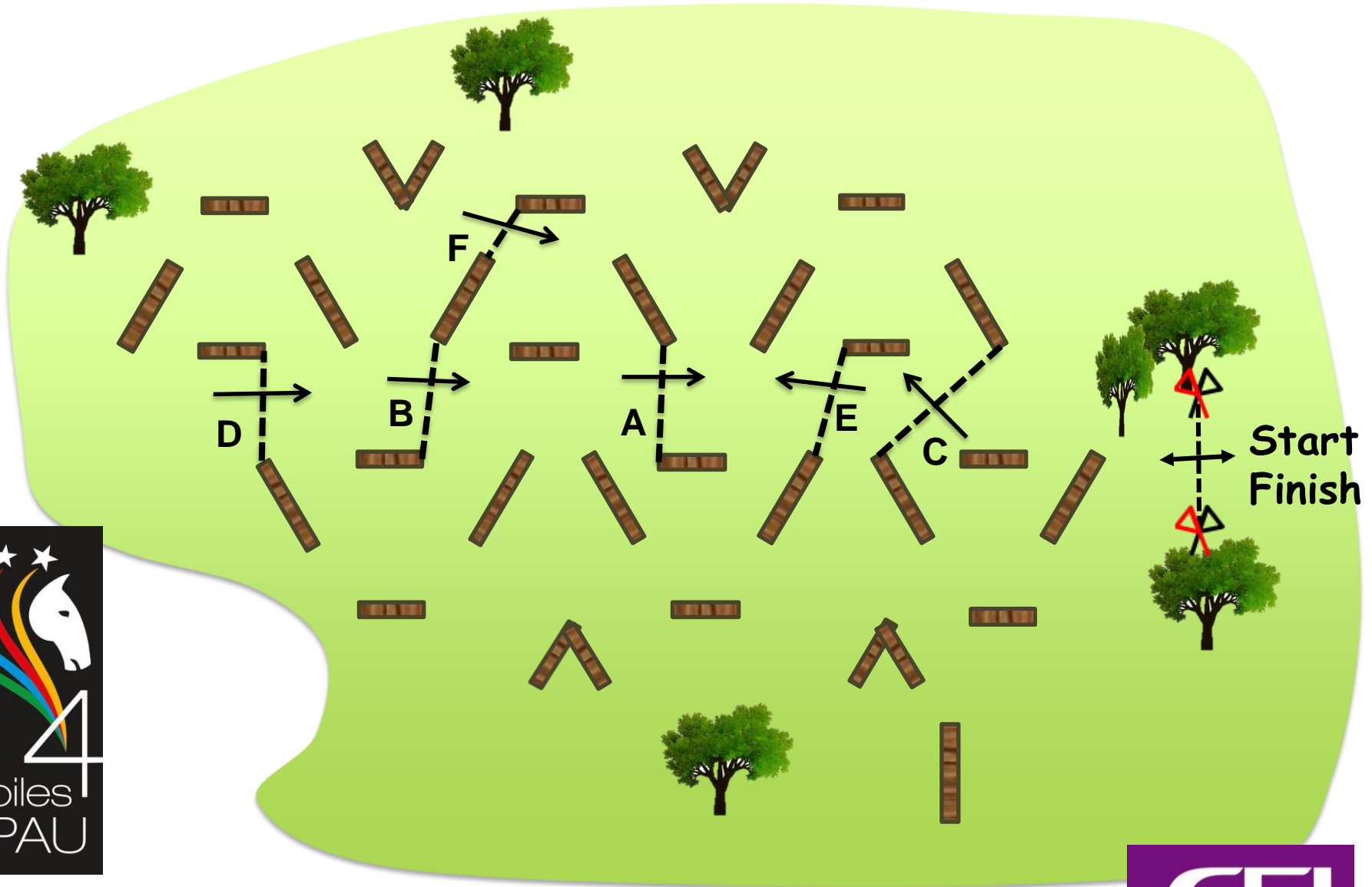

# Obstacle n°2

Start Finish

Dislodgeable elements

★ 4

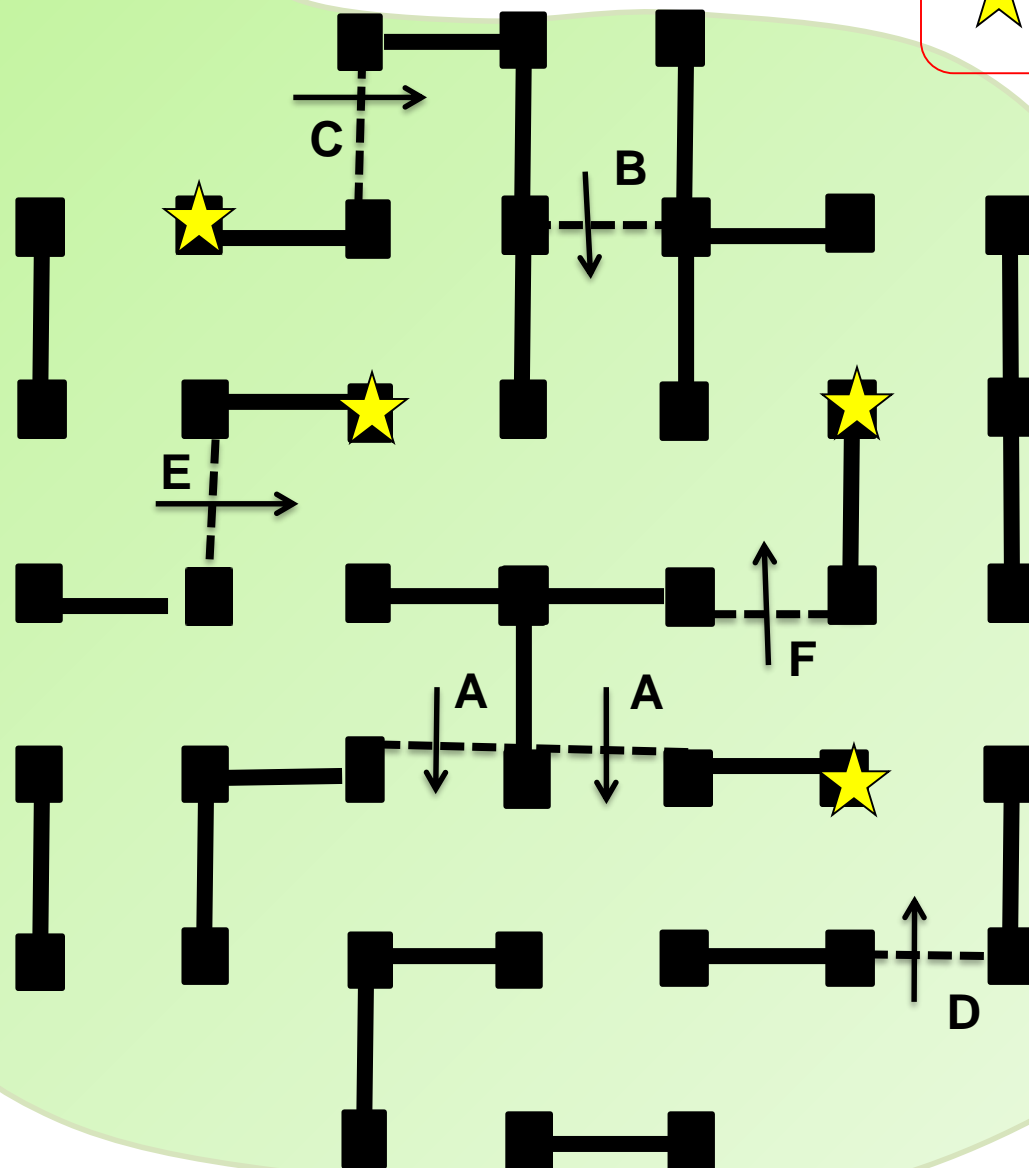

# Obstacle n°3

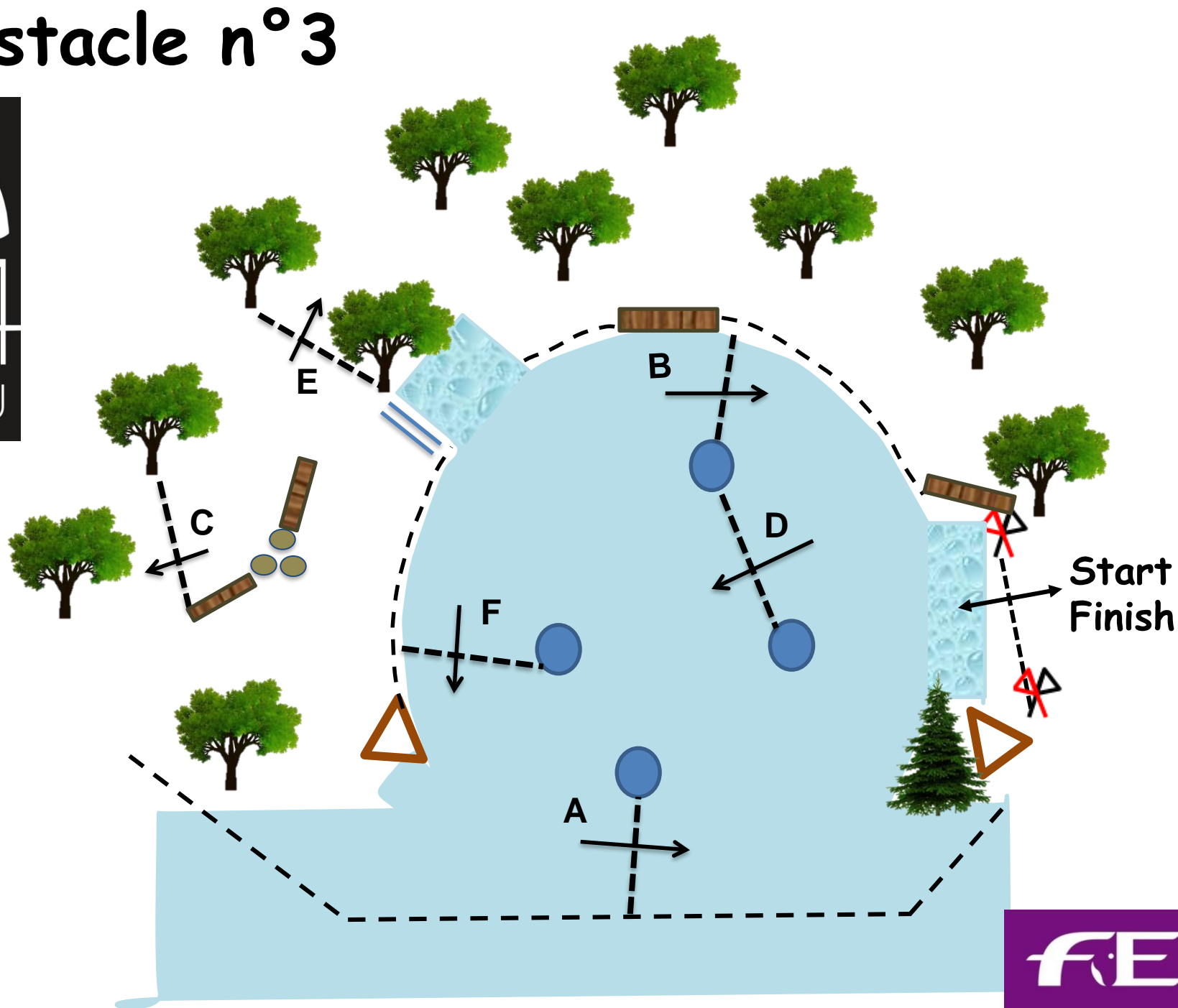



# Obstacle n°4

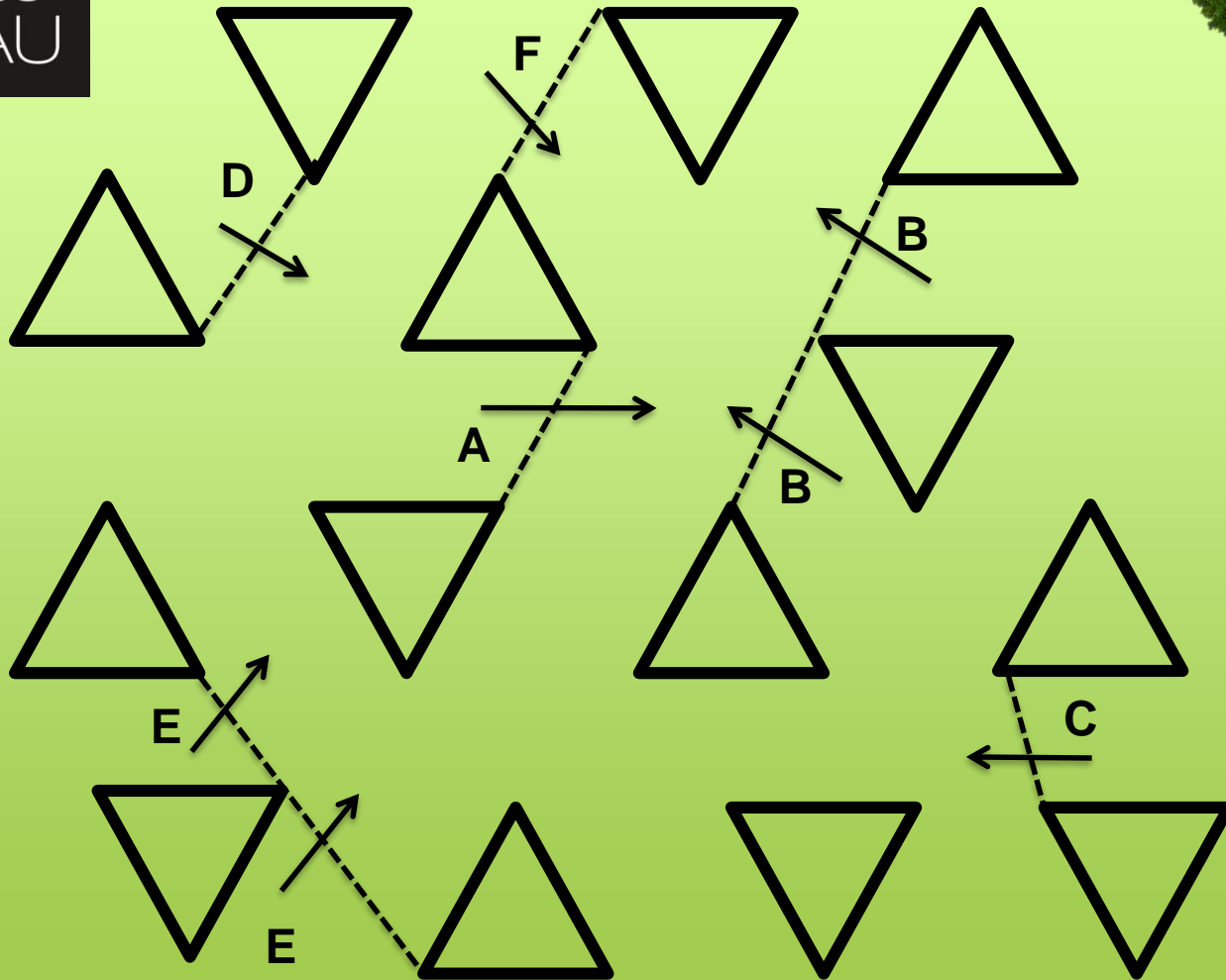

# Obstacle n°5

Dislodgeable elements



3

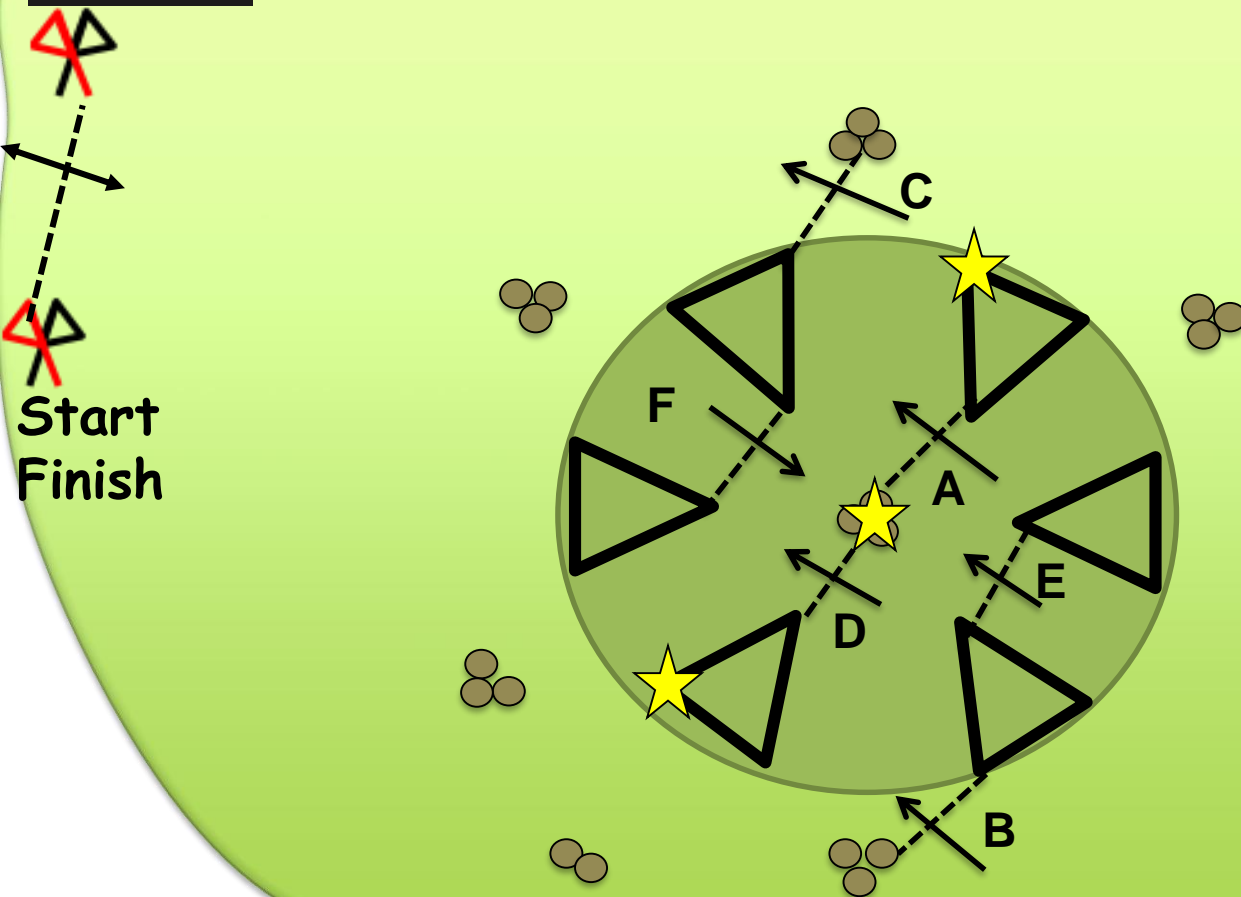



# Obstacle n°6

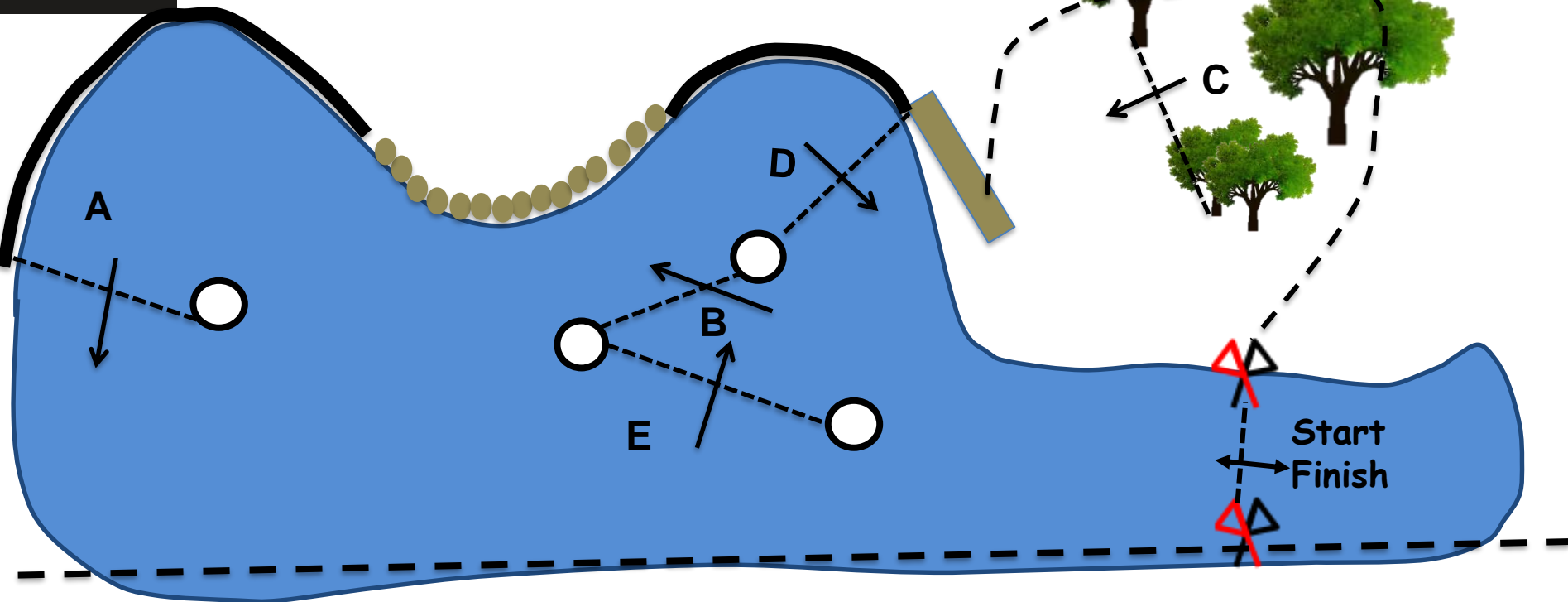

# Obstacle n°7

Dislodgeable elements



10

Start  
Finish

